

# Corbels (Shelf Brackets)

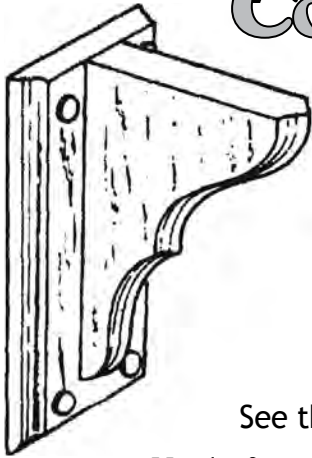

ITEM #	SIZE (AxB)	PRICE
TWB-401	4" x 6"	\$ 7.33
TWB-601	6" x 9"	10.69
TWB-801	7-1/4" x 11-1/4"	13.86
TWB-1001	9-3/4" x 13"	16.30

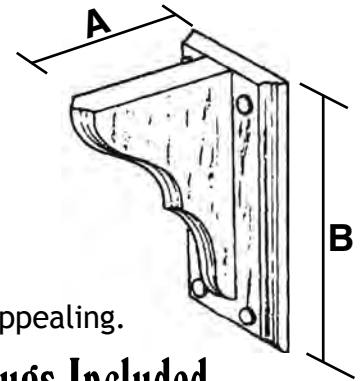

See thru packaging keeps brackets fresh-looking and appealing.

**Made from Clear Ponderosa Pine. Screws & Hole Plugs Included.**

## BULLNOSE CORNERS, ROSETTES, PLINTH BLOCKS, RADIUS CORNERS & BASE CORNERS

### Bullnose Corner Blocks

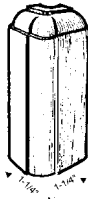

Grand Junction & Casper Stocked Only

4" Pine Corner Block  
BS4PCB \$3.10

4" Pine IS Corner Block  
BS4IPCB \$2.31

4" Oak Corner Block  
BS4OCB \$5.58  
(No Routing)

### Rosettes

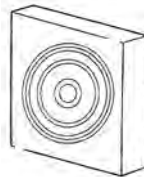

2-1/2" x 2-1/2" x 3/4"  
642-OAK \$2.21  
642-ALDER 1.82

3-1/2" x 3-1/2" x 3/4"  
734-MDF \$2.21  
734-OAK 3.20  
734-ALDER 2.94

### Plinth Blocks

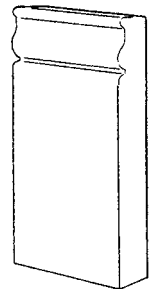

6" x 3-1/2" x 3/4"  
742PB-MDF \$2.21  
742PB-OAK 4.29  
742PB-ALDER 2.87

### Radius Drywall Corners- 3/4" Radius

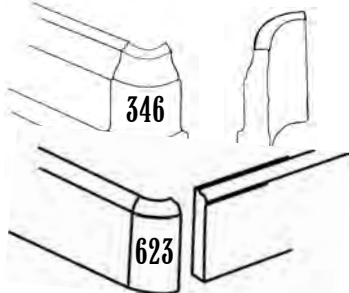

WM346-PINE 2-1/4" \$1.92  
WM346-OAK 2-1/4" 2.71  
  
WM623-PINE 3-1/4" 2.31  
WM623-OAK 3-1/4" 3.24

### Universal Base Corners

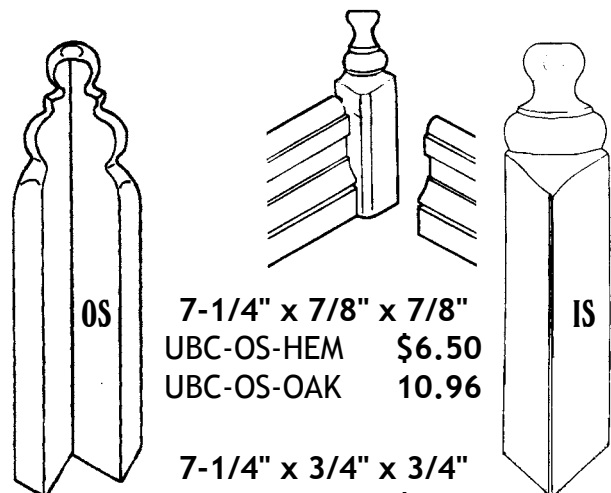

7-1/4" x 7/8" x 7/8"  
UBC-OS-HEM \$6.50  
UBC-OS-OAK 10.96  
  
7-1/4" x 3/4" x 3/4"  
UBC-IS-HEM \$2.67  
UBC-IS-OAK 3.90



# Ventilated Wire Shelving Systems

- *Storage Rooms*
- *Laundry/Utility*
- *Bedroom Closets*
- *Kitchen Pantries*
- *Linen Closets*
- *Garages*

Dependability since 1959! Rubbermaid® manufacture the nation's leading lineup of ventilated wire shelving, basket systems, door/wall racks, shoe racks and specialty storage accessories.

Rubbermaid® is an innovator in the storage industry with introductions of patented products such as FreeSlide® shelving and FastSet hardware.

Our products are made with industrial-grade steel coated with a durable, smooth and environmentally-friendly epoxy finish. Rubbermaid® is proud to be an American manufacturer.

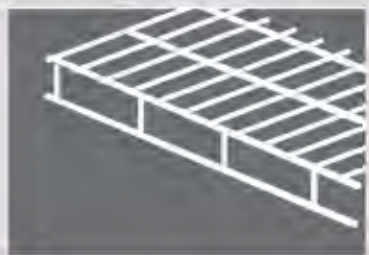

## Shelf and Rod

12" x 12' and 16" x 12' shelves



## Free Slide

### White

12" x 12' and 16" x 12' shelves  
12" and 16" corner shelf

### Satin Nickel

12" x 12' and 16" x 12' shelves  
12" corner shelf

**RW Stocked  
Call  
For  
Current  
Pricing**



## Linen

9" x 12', 12" x 12', shelves  
16" x 12' and 20" x 12' shelves

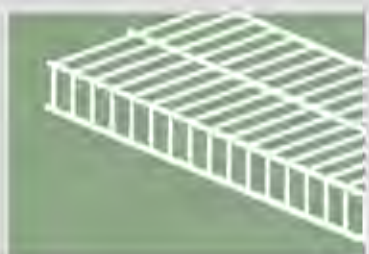

## Tight Mesh

### White

12" x 12', 16" x 12' and 20" x 12' shelves

### Satin Nickel

12" x 12', 16" x 12' and 20" x 12' shelves

RW stocks the above wire shelving and all of the necessary hardware for all of the above wire shelving systems. Our salesmen will assist you in ordering all of the components needed for your Bedroom closet, Linen closet, Pantry, Laundry Room, Storage Room, Garage, or any other use you can think of!

# Lido ORB, Chrome & Brushed Nickel Closet Rods

A Division of Lavi Industries

Now You Can Forget Those Sagging Wooden Hang Rods by Using Sturdy Metal Components From Lavi Industries.



## Tubing 1<sup>15</sup>/<sub>16</sub>"

LB-10-A106/6	Chrome - 6'	\$ 36.37
LB-10-A106/8	Chrome - 8'	48.61
LB-10-A106/12	Chrome - 12'	87.22
LB-44-A106/6	Brushed Nickel - 6'	49.34
LB-44-A106/8	Brushed Nickel - 8'	62.64
LB-07-A106/6	Oil Rubbed Bronze - 6'	66.78
LB-07-A106/8	Oil Rubbed Bronze - 8'	83.67

## Shelf/Rod Bracket

LB-10-8150	Chrome	\$13.25
LB-14-8150	Brushed	15.04
LB-07-8150	Oil Rub. Bronze	16.52

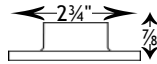

## Flanges

LB-10-505SET	Chrome	9.19
LB-14-505SET	Brushed Nickel	9.97
LB-07-505SET	Oil Rubber Bronze	12.55

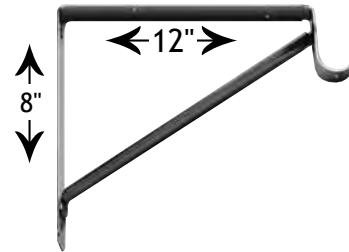

# AROMATIC RED CEDAR CLOSET LINER

ADDS BEAUTY, PROTECTION, & DISTINCTION TO ANY CLOSET.

15 Sq. Ft. per Carton  
3<sup>7</sup>/<sub>8</sub>" Wide x 48" Long  
x 3<sup>8</sup>/<sub>8</sub>" Thick

Item # OZARK-15  
\$34.58 Per Carton

TONGUE & GROOVE EDGES



ALL 4 SIDES.

- Bedroom Closets
- Linen Closets
- Pantry
- Sink Cabinets
- Attic Storage Areas
- Garage Storage
- Pet Areas
- Chests and Drawers

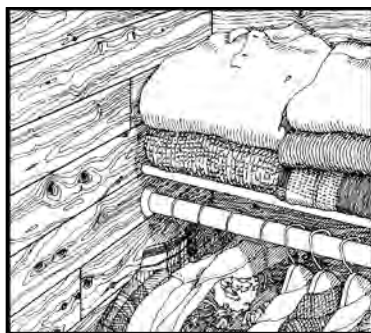

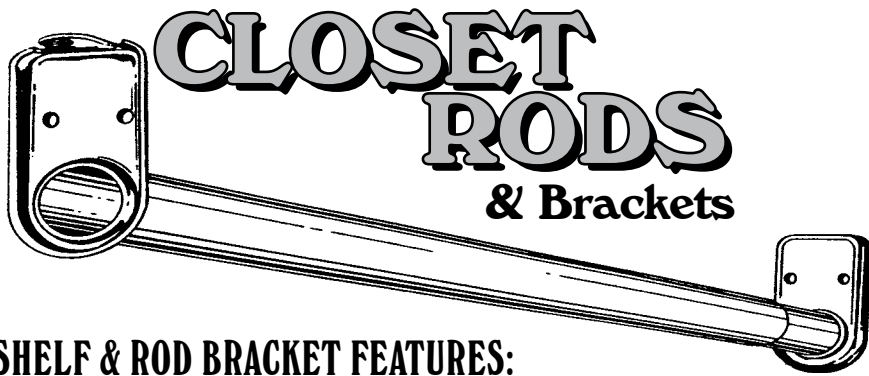

# CLOSET RODS & Brackets

## ADJUSTABLE

### SHELF & ROD BRACKET FEATURES:

Bright Zinc Baked Finish or White Powder Coat Finish.

Extra Strength Construction Designed for Maximum Rigidity. All Styles Available.

Bright Zinc or White Powder Coat Finishes & High Strength Lock Seam Tubing

ITEM #	DESCRIPTION	SIZE	COLOR	#/CTN	PRICE
PB002218/30	Adjustable Rod	18" - 30"	Bright Zinc	10	\$ 4.76
PB002218/30WT	Adjustable Rod	18" - 30"	White Powder Coat	10	6.61
PB002230/48	Adjustable Rod	30" - 48"	Bright Zinc	10	6.27
PB002230/48WT	Adjustable Rod	30" - 48"	White Powder Coat	10	8.06
PB002248/72	Adjustable Rod	48" - 72"	Bright Zinc	10	9.03
PB002248/72WT	Adjustable Rod	48" - 72"	White Powder Coat	10	11.36
PB002272/96	Adjustable Rod	72" - 96"	Bright Zinc	10	11.82
PB002272/96WT	Adjustable Rod	72" - 96"	White Powder Coat	10	15.18
PB002272/120	Adjustable Rod	72" - 120"	Bright Zinc	10	14.36
PB002272/120WT	Adjustable Rod	72" - 120"	White Powder Coat	10	17.70
PB002296/150	Adjustable Rod	96" - 150"	Bright Zinc	10	16.30
PB002296/150WT	Adjustable Rod	96" - 150"	White Powder Coat	10	19.67

**All Rods are Packed 10 per Carton**

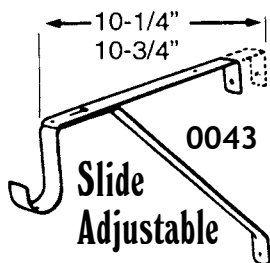

Slide  
Adjustable

### White Powder Coat Shelf & Rod Brackets

0043-WTS	Adj. S&R Bracket	20	\$ 5.00
0045-WTS	Non-Adj. S&R Bracket	20	3.97



Non  
Adjustable



0037

Plastic Pole Sockets  
For 1-3/8" Pole

ITEM #	DESCRIPTION	QTY	PRICE
BN-0037	Closet Pole Socket	100	\$ .82
0043-B	Adj. S&R Bracket	20	3.70
0044-B	Non-Adj. S&R Bracket	20	2.82
0045-B	Heavy Duty S&R Bracket	20	3.55

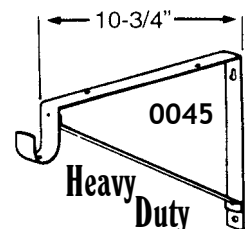

Heavy  
Duty

# TRAK-MOUNT™

## HEAVY DUTY SHELVING SYSTEMS

For Garage, or Anywhere  
You Need Heavy Duty Shelving  
Can be Used with Rubbermaid Wire  
Shelving Systems

R/W Stocked in White Powder Coat Finish (Also Available in Durable White & Black Powder Coat Finishes)

### HEAVY DUTY UPRIGHTS

0119-78WT 78" Heavy Duty Uprights (6/ctn.) \$ 17.91

### DUAL SLOT UPRIGHTS

0120-25WT	25" Dual Slot Uprights	(10/ctn.)	\$ 4.45
0120-48WT	48" Dual Slot Uprights	(10/ctn.)	8.18
0120-63WT	63" Dual Slot Uprights	(10/ctn.)	10.70
0120-70WT	70" Dual Slot Uprights	(10/ctn.)	11.94
0120-78WT	78" Dual Slot Uprights	(10/ctn.)	14.03

0119



0120



0121

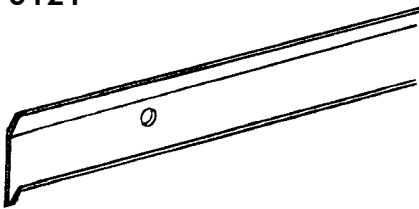

### HORIZONTAL HANG TRAK - White

0121-40WT	40" Horizontal Hang Trak	(6/ctn.)	\$ 10.61
0121-80WT	80" Horizontal Hang Trak	(6/ctn.)	18.64

Hang Trak Is Load Rated To 200 Lbs. Per Screw Into Studs,  
Or 100 Lbs. Per Anchor Into Drywall.

### SHELF BRACKETS - White

0122-7WT	7" Shelf Bracket	(20/ctn.)	\$ 2.85
0122-11WT	11" Shelf Bracket	(20/ctn.)	3.42
0122-14WT	14" Shelf Bracket	(20/ctn.)	4.61
0122-19WT	19" Shelf Bracket	(20/ctn.)	7.18

0122

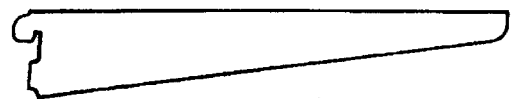

Trak-Mount Brackets  
Are Load Tested To A Minimum  
Of 100 Lbs. Per Bracket.

## Miscellaneous Hardware

CD-0142-WT	White Fasteners (14)	4.22
CD-0143-WT	White Bracket Screws (20)	6.15

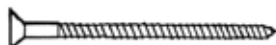
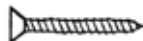
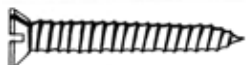

## 2 WAYS TO MOUNT SHELVING SYSTEMS

Hang Uprights from Mounted Hang Trak,  
OR  
Mount Uprights to Wall with Screws