

Starting Steps, Treads, Risers, Mouldings & Tread Covers



Single end starting steps are either right or left hand. Please specify. Add 5% for reversible.

Starting steps made to order - please check time.



NOTE: Add to all starting steps - \$32.00 for each 12" over the 48" shown. Radius end cove and/or shoe optional at \$36.00 per each cove or shoe (includes straight piece).

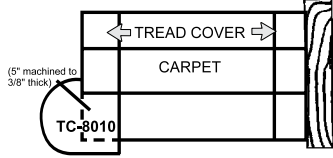

TC-8010-5" \$140.00
Designed for use on stairs with volutes or turnouts, using tread covers. 5" machined to 3/8" thick. Radius end cove included.

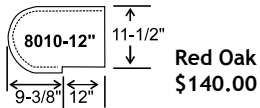

Red Oak \$140.00

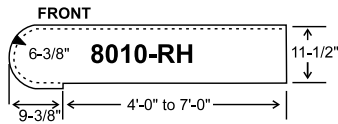

Red Oak 48" \$195.00

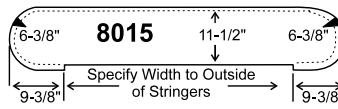

Red Oak 48" \$280.00

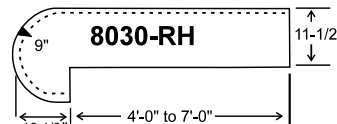

Red Oak 48" \$260.00

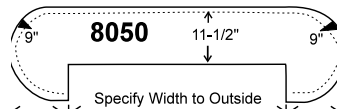

Red Oak 48" \$340.00

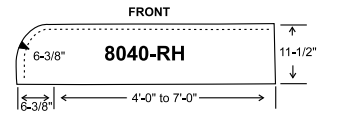

Red Oak 48" \$220.00

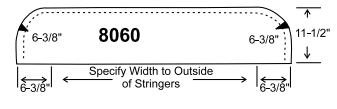

Red Oak 48" \$270.00

NOSING



1-1/16" x 1-1/4" \$2.20
8080-RO
8080-A \$2.60
HN - \$1.30 (Hemlock)

COVE



3/4" x 3/4" \$1.20
8095-RO

SHOE



5/8" x 3/4" \$0.96
8422-RO

DECORATIVE BRACKETS



5/16" x 7-5/8" x 11-1/2" \$9.00
7029 RO



5/16" x 8-1/4" x 11-1/2" \$8.00
7028 RO

LANDING TREAD



1-1/16" X 3-1/2" \$4.90
8090-RO
HLT \$3.50 (Hemlock)

1-1/16" x 5-1/4" \$8.40
8090-5 RO

TREAD COVERS

Solid Panel 3/8" Thick; Nosing 1" x 1-3/8"; Cove 3/4" x 3/4".

Can be job cut right or left hand (left shown).

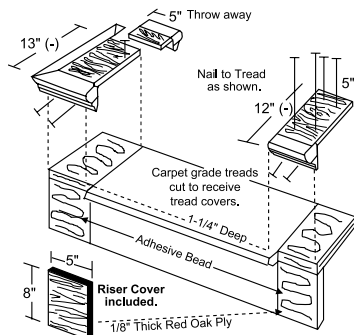

Tread Cover Wall End

Code TRC-WE
Red Oak \$14.50
Maple 19.00
Alder 22.00
Cherry 26.00

Tread Cover Open End

Miter Return
Code TRC-OE
Red Oak \$20.00
Maple 29.00
Alder 30.00
Cherry 34.00

Riser Cover Also Sold Separately \$4.00

(Cove Moulding unattached)

www.rwspecialties.com

TREADS & RISERS



1-1/16" x 11-1/2" \$41.70
8070 PLAIN TREAD

3/4" x 7-1/4" \$19.00
8075-RO RISER

	Red Oak	Hemlock	Red Oak
36"	\$ 41.70	\$ 24.00	\$19.00
42"	48.65	27.00	22.00
48"	55.60	30.00	26.00
60"	69.50	38.00	32.00
72"	83.40	--	40.00
96"	120.00	--	

Hemlock Treads are Finger Jointed

**MITERED RETURN
TREAD
ADD \$30.00
TO PLAIN TREADS**

**Custom Sizes
& Species
Available on Quote.**

Stair Accessories



Brackets and Clamps for Bending Rail!

Heavy Duty Steel Leveling & Forming Brackets.

BALB-B	BEND-AID Leveling Bracket	4.50
	Type B for 2-3/8" High Rail	
BAFB	BEND-AID Forming Bracket	16.00
BA-C	"C" Clamps - 5" Heavy Duty	16.00

Patent No. 4,960,137

Wall Rail Brackets

Note: All Finishes Not Shown



3003 - \$6.50



3002
Antique Brass \$2.70
Brass Plated 2.70
Brushed Nickel 2.70
Oil Rub. Brz. 2.70

ABZ	Antique Bronze	C	Chrome
AN	Anitque Nickel	ORB	Oil Rubbed Bronze
B	Black	ORC	Oil Rubbed Copper
BP	Brass Plated	PC	Powder Coated
BN	Brushed Nickel	SAT	Satin Black



310
Solid Brass \$21.62

NEWEL ATTACHING HARDWARE The Original Newel / Post Anchor System

NAH-ALDER	\$ 16.00	NAHM-A	Moulding only	\$ 2.40 LF
NAH-CHERRY	17.00	NAHM-CH	Moulding only	3.00 LF
NAH-HEMLOCK	15.00	NAHM-HEM	Moulding only	1.20 LF
NAH-MAPLE	16.00	NAHM-M	Moulding only	2.50 LF
NAH-OAK	15.50	NAHM-RO	Moulding only	1.80 LF

NB Bracket only with Screws 2.00 EA

Other species wood trim on order & quote.

Patent #4,381,160

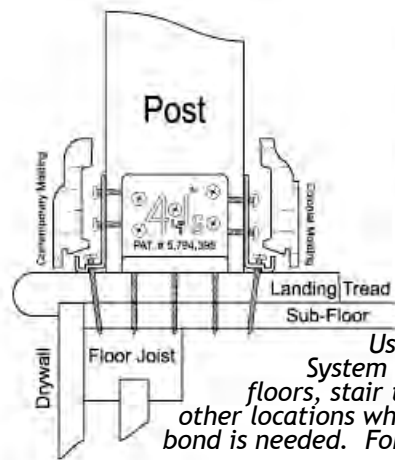

4J's™
Post Mounting System™
PAT. # 5,794,395

Use the 4J's Post Mounting System to mount newel posts to floors, stair treads, landing treads or other locations where a strong, permanent bond is needed. For interior or exterior use

CONTEMPORARY			
For 3" Posts		For 3-1/2" Posts	
4J-3RO	Oak \$18.90	4J-35RO	Oak \$19.40
4J-3A	Alder 18.90	4J-35A	Alder 19.40
4J-3M	Maple 18.90	4J-35M	Maple 19.40
		4J-35S	Softwood 18.90
CONTEMPORARY MOULDING ONLY			
4J-ROM	Oak 4.80LF	4J-MAM	Maple 4.80LF
4J-AM	Alder 4.80LF	4J-SM	Softwood 4.48LF
COLONIAL			
4J-35ROC	Oak 19.40	4J-35ROMC	Oak 4.80LF
	for 3-1/2" Post		Moulding only
4J-325HC	Hemlock 18.90	4J-325HC	Hemlock 4.48LF
	for 3-1/4" Post		Moulding only

Stair Accessories



ROSETTES

7017
Round



3/4" x 4-3/8"
Oak, Alder \$6.00
Hemlock \$5.00

7037
Oval



3/4" x 4" x 4-5/8"
Oak, Alder \$6.00
Hemlock \$5.00

7017 NC
Round



No Cup
Oak, Alder \$6.00

7037 NC
Oval



No Cup
Oak, Alder \$6.00

Other Species Available
on Quote

1" TAPERED FLAT-GRAIN PLUG
Alder, Oak, Hemlock,
Cherry & Maple

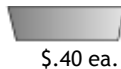

\$.40 ea.

Retail Packed Newel, Baluster & Handrail Installation Hardware

Baluster Bolt Kits

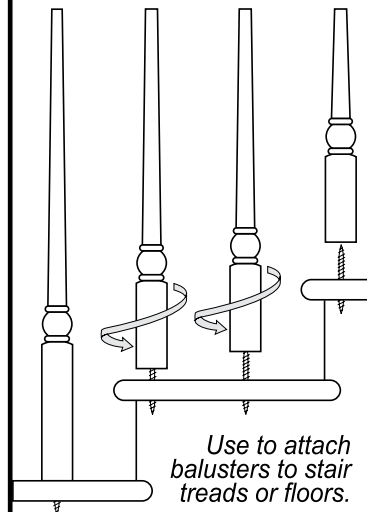

Use to attach
balusters to stair
treads or floors.

#12023 10 pack w/tool \$7.69
#12024 20 pack 6.69
#12025 50 pack 16.29

Handrail Bolt Kit

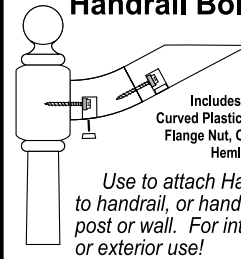

Includes: 4" Bolt,
Curved Plastic Washer,
Flange Nut, Oak Plug,
Hemlock Plug

Use to attach Handrail
to handrail, or handrail to
post or wall. For interior
or exterior use!

Item #11542 \$3.59

Post Bolt Kit

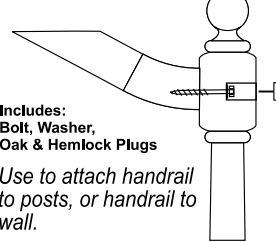

Includes:
Bolt, Washer,
Oak & Hemlock Plugs

Use to attach handrail
to posts, or handrail to
wall.

Item #13042 \$3.79

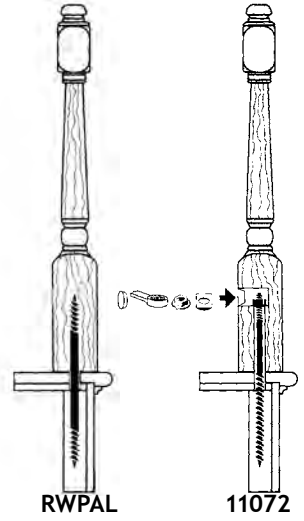

RWPAL

11072

RWPAL - Post Aid Lag
\$7.50

11072 - Newel Post Fastener
\$14.34

CLAMP NAILS \$0.10 Ea.

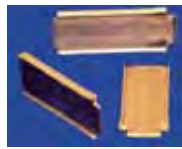

Installation Tool Handrail Bolt Wrench

Item 43221 \$18.00
Easy, Single Handed-Operation
for Installing Handrail Bolts.

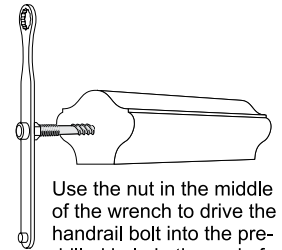

Use the nut in the middle
of the wrench to drive the
handrail bolt into the pre-
drilled hole in the end of
the handrail.

RAIL BOLT
\$1.00 ea.



The Following Items are Stocked in Salt Lake City Only.

RWTRCOE False Tread

Oak \$26.00
12 1/2" x 6"

Maple \$23.00
12 1/2" x 6"

Specify Right or Left Hand

Alder \$22.00
12 1/2" x 6"

Specify Right or Left Hand

TRCR False Riser

6"W x 8"H
Oak \$3.50
Maple 3.50
Alder 2.25

This riser comes with RWTRCOE &
RWTRCWE and included in price



(Nosing & Cove
are attached)

See page 15 for
Denver, Grand
Junction & Casper
Stocked Tread Covers

False Tread & Risers

RWTRCWE Wall Cap

Oak \$13.00
12 1/2" x 6"

Maple \$12.00
Alder \$10.00
12 1/2" x 6"

RWTRCM Molding Tread Nosing & Cover

Oak \$3.50 LF.
Maple 4.05 LF.
Alder 2.25 LF.

Matches molding
on RWTRCOE

Apron Molding

RWA175AO Oak \$2.50
RWA175AM Maple 2.50
RWA175AA Alder 2.50
RWA175AF Fir 3.45
RWA175AC Cherry 5.00



RWBOLT - Rail Bolt, Flange Nut & Cam
\$ 1.70

Rail Bolt Package

Includes: Bolt, Plug and Cam \$2.75 pkg.

RWBOLT-A Alder
RWBOLT-H Hemlock
RWBOLT-M Maple
RWBOLT-RO Oak

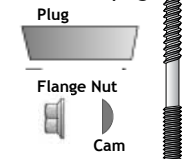

1/2" Plugs - Flat

1500-A 1/2" Alder Plug \$.40 ea
1500-M 1/2" Soft Maple Plug .40 ea

Rail Bolt