



Mirror Doors

Bi-Pass

ALUMINUM NARROW STILE (11/16") BY-PASS

BRUSHED NICKEL

11/16" wide stiles
 Integral full-length finger pulls
 Felt lined top guides
 Large bottom rollers with integral anti-jump feature
 One piece 2 3/16" deep, 2 faced top track
 Low rise bottom track
 3.0mm 400 lb. Cat II safety backed mirror

ITEM #	DESCRIPTION / COLOR	PRICE
ANM501-4068BW	48" X 80 1/2" BRUSHED NICKEL	\$238.93
ANM501-5068BW	60" X 80 1/2" BRUSHED NICKEL	278.77
ANM501-6068BW	72" X 80 1/2" BRUSHED NICKEL	318.37

STEEL MIRRORLESS BI-PASS

Adjustable top L-guides
 Large bottom rollers with integral anti-jump feature
 One piece 1-3/4" deep top track
 Low rise bottom track
 3.0 mm 400 lb. CAT II Safety backed mirror

ITEM #	DESCRIPTION / COLOR	PRICE
SM101-4068BW	47" X 80 1/2" BRIGHT WHITE	\$158.20
SM101-5068BW	59" X 80 1/2" BRIGHT WHITE	186.89
SM101-6068BW	71" X 80 1/2" BRIGHT WHITE	220.48

Bi-Fold

STEEL FRAMED BI-FOLD

1/4" Frame around mirror
 Interchangeable dual-height tracks
 Spring enhanced hinges
 Color coordinated pull handles
 3.0 mm 400 lb. CAT II Safety backed mirror

ITEM #	DESCRIPTION / COLOR	PRICE
SBM301-2068BW	24" X 80 1/2" BRIGHT WHITE	144.66
SBM301-2668BW	30" X 80 1/2" BRIGHT WHITE	160.48
SBM301-3068BW	36" X 80 1/2" BRIGHT WHITE	176.30

Bi-Pass

ALUMINUM NARROW STILE (11/16") BY-PASS

OIL RUBBED BRONZE

11/16" wide stiles
 Integral full-length finger pulls
 Felt lined top guides
 Large bottom rollers with integral anti-jump feature
 One piece 2 3/16" deep, 2 faced top track
 Low rise bottom track
 3.0mm 400 lb. Cat II safety backed mirror

ITEM #	DESCRIPTION / COLOR	PRICE
ANM501-4068ORB	48" X 80 1/2" OIL RUBBED BRZ	\$279.55
ANM501-5068ORB	60" X 80 1/2" OIL RUBBED BRZ	326.19
ANM501-6068ORB	72" X 80 1/2" OIL RUBBED BRZ	372.51

STEEL FRAMELESS BI-PASS

Polished edge mirror
 Adjustable top L-guides
 Large bottom rollers with integral anti-jump feature
 One piece 1-3/4" deep top track
 Low rise bottom track
 3.0 mm 400 lb. CAT II Safety backed mirror

ITEM #	DESCRIPTION / COLOR	PRICE
SFM201-4068BW	47" X 80 1/2" BRIGHT WHITE	\$223.82
SFM201-5068BW	59" X 80 1/2" BRIGHT WHITE	256.21
SFM201-6068BW	71" X 80 1/2" BRIGHT WHITE	288.90

Bi-Fold

STEEL FRAMELESS BI-FOLD

Polished edge mirror
 Non -visable frame on long sides
 Interchangeable dual-height tracks
 Spring enhanced hinges
 Color coordinated pull handles
 3.0 mm 400 lb. CAT II Safety backed mirror

ITEM #	DESCRIPTION / COLOR	PRICE
SBFM401-2068BW	24" X 80 1/2" BRIGHT WHITE	157.32
SBFM401-2668BW	30" X 80 1/2" BRIGHT WHITE	174.87
SBFM401-3068BW	36" X 80 1/2" BRIGHT WHITE	191.99

Damage to Mirror Doors Must be Reported to RW Within 24 Hours.

NOTE: There is a 30% Re-Stocking Charge on All Mirror Doors

GENERAL DESCRIPTION

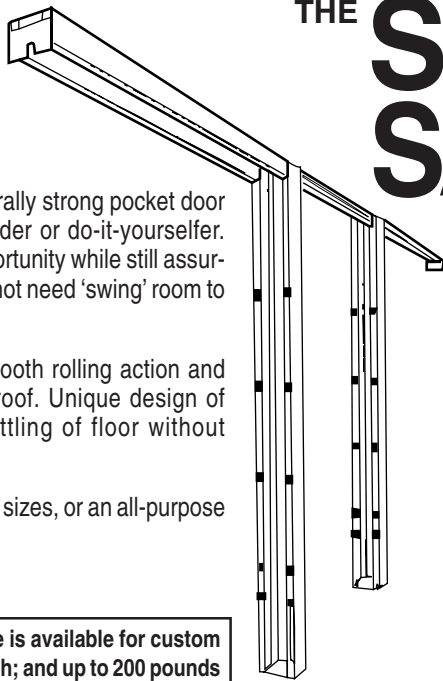

THE SPACE SAVER

An easily assembled, structurally strong pocket door frame. Designed for the builder or do-it-yourselfer. Provides a space saving opportunity while still assuring privacy. Pocket doors do not need 'swing' room to use valuable floor space.

Tricycle hangers provide smooth rolling action and are GUARANTEED jump proof. Unique design of floor brackets allow for settling of floor without distorting header track.

Available for all standard door sizes, or an all-purpose size to minimize inventory.

NOTE: The 1500 Series Frame is available for custom doors up to 5'0" wide; 9'0" high; and up to 200 pounds in weight.

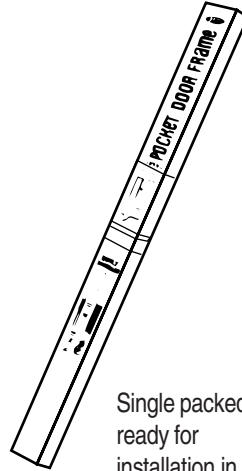

Single packed ready for installation in rough opening

EXCEPTIONAL FEATURES

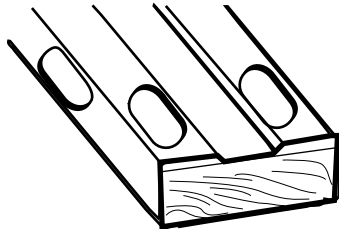

STRONG STIFFENERS

Split jamb and stud uprights have full steel sides and backs to provide maximum rigidity for wall material and restricts nails from penetration into pocket. Slots allow room for easy nailing of trim stops.

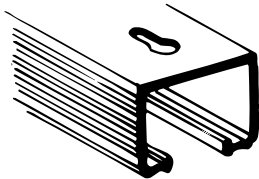

REMOVABLE TRACK

Track has keyhole slots for easy removal without tearing out walls. Box design prevents rollers from jumping track. Convex rails provide one-point wheel contact for smoothness — dirt traps for free rolling.



TRICYCLE HANGERS

Tri-design insures all wheels carry weight equally. Smooth rolling, balanced wheels ride with minimum friction on convex track rails. A 'flip-of-a-clip' separates hangers from doors for easy door removal.

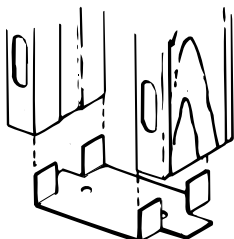

*SELF-ADJUSTING FLOOR ANCHORS

Long vertical fingers slide into split studs — allow for settling of floor without disturbing horizontal alignment of header and track. Plates can be nailed or cemented to floor.

*NOTE: 1-3/4" doors require Pt. No. 1575 Adaptor Kit. See OPTIONAL listing.

JOHNSON
HARDWARE

**MOUNTED TRACK
TRICYCLE
HANGERS
COMPACT**

**POCKET
DOOR
FRAME**

For
1-1/8" To 1-3/4"
Doors
(Max. wt.
125 LBS.)

SERIES 1500

**COMPLETE WITH SCREWS
AND INSTRUCTIONS**

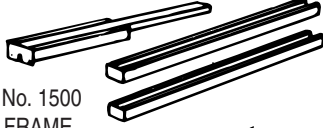

No. 1500
FRAME



No. 100
TRACK
(Attached
to header)



(2 ea)
No. 1120
TRICYCLE
HANGERS
(1" DIA. WHEELS)



No. 1550
DOOR GUIDES

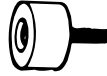

No. 1513
DOOR BUMPER



No. 1712
ADJ. WRENCH

OPTIONAL HANGER

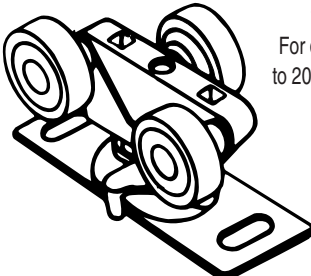

1125
For doors
to 200 lbs.

Ball Bearing wheels provide smooth, quiet, easy operation of very heavy doors. Need no lubrication.