

DURAFLEX

The Original Flexible Moulding from Resinart

The Professional's Choice Since 1968

DuraFlex® is the original economical alternative to curved wood applications where wood mouldings simply won't bend or conform to the design concept.

Available in oak, pine or smooth grain, DuraFlex is less expensive than traditional curved millwork. DuraFlex one-piece construction provides flexibility that always insures a proper fit. DuraFlex can be cut, shaped installed and stained or painted like traditional wood mouldings.

Using Resinart's Advanced Polymer Technology™, DuraFlex is consistently specified by architects and builders who demand the best.

CASING



WM 346

9/16 X 2-1/4

8' - \$46.17

10' - \$49.88

12' - \$59.60



WM 356

11/16 X 2-1/4

10' - \$69.46



WM 346

11/16 X 3-1/2

12' - \$80.62

MISCELLANEOUS



WM 291

3/4 X 1-15/16

12' - \$47.33



WM 126

1/2 X 3/4

Oak

12' - \$26.10



WM 126

1/2 X 3/4

Smooth

12' - \$26.10



WM 916

3/8 X 1-1/4

10' - \$26.10



1 x 6 & 1 x 8
Flat Stock

1 x 6 x 12' - \$203.58

1 x 8 x 12' - \$267.61

BASE



WM 623

9/16 X 3-1/4

8' - \$61.02

10' - \$76.27

12' - \$91.52



WM 852

9/16 X 3-1/4

10' - \$84.22



WM 811

11/16 X 4-1/2

10' - \$99.47



TABOR M

11/16 X 4-3/4

10' - \$151.96

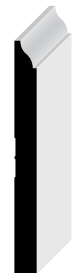

WM 618

9/16 X 5-1/4

10' - \$128.47



TABOR S

11/16 X 7

10' - \$204.16

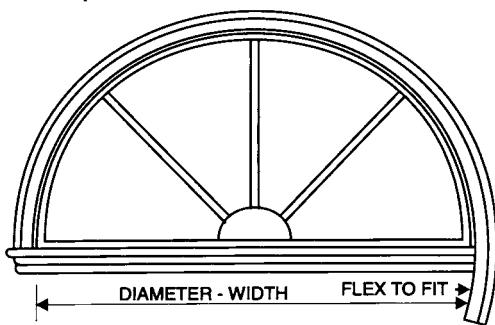

PREFORMED DIAMETER

MOULDING

Stainable Pine

(Flexible 6" Either Way)

DIAM	#346	#356
3'0"	\$34.80	\$37.41
4'0"	\$40.60	\$43.65
5'0"	\$61.45	\$56.12
6'0"	\$63.80	\$68.59

Denver Stocked Only

Special Order from over 18,000 available profiles. Call or fax any pattern.
We may already have the moulding pattern you need!



www.resinart.com

www.rwspecialties.com

2012 RW Specialties Dealer Catalog 33

Corbels (Shelf Brackets)

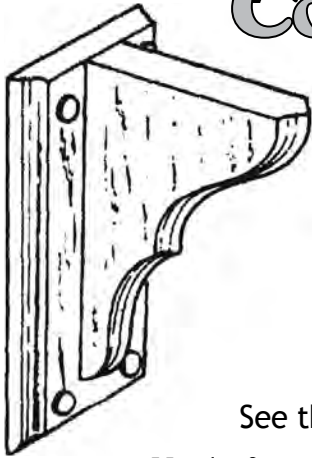

ITEM #	SIZE (AxB)	PRICE
TWB-401	4" x 6"	\$ 7.33
TWB-601	6" x 9"	10.69
TWB-801	7-1/4" x 11-1/4"	13.86
TWB-1001	9-3/4" x 13"	16.30

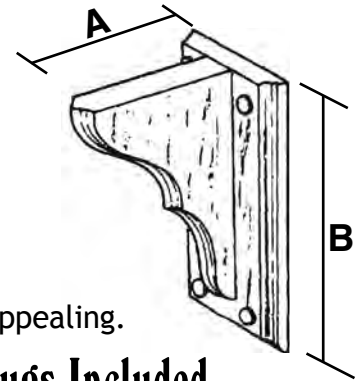

See thru packaging keeps brackets fresh-looking and appealing.

Made from Clear Ponderosa Pine. Screws & Hole Plugs Included.

BULLNOSE CORNERS, ROSETTES, PLINTH BLOCKS, RADIUS CORNERS & BASE CORNERS

Bullnose Corner Blocks

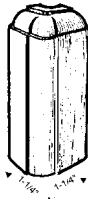

Grand Junction & Casper Stocked Only

4" Pine Corner Block
BS4PCB \$3.10

4" Pine IS Corner Block
BS4IPCB \$2.31

4" Oak Corner Block
BS4OCB \$5.58
(No Routing)

Rosettes

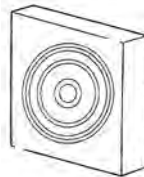

2-1/2" x 2-1/2" x 3/4"
642-OAK \$2.21
642-ALDER 1.82

3-1/2" x 3-1/2" x 3/4"
734-MDF \$2.21
734-OAK 3.20
734-ALDER 2.94

Plinth Blocks

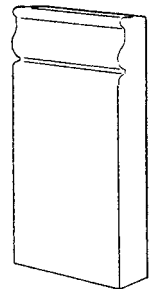

6" x 3-1/2" x 3/4"
742PB-MDF \$2.21
742PB-OAK 4.29
742PB-ALDER 2.87

Radius Drywall Corners- 3/4" Radius

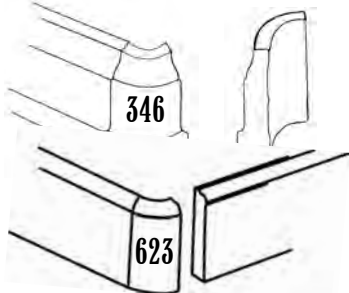

WM346-PINE 2-1/4" \$1.92
WM346-OAK 2-1/4" 2.71
WM623-PINE 3-1/4" 2.31
WM623-OAK 3-1/4" 3.24

Universal Base Corners

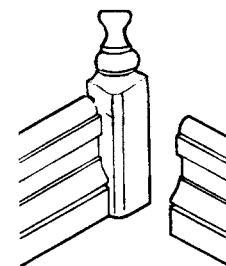
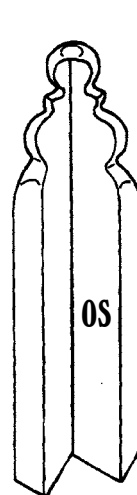

7-1/4" x 7/8" x 7/8"
UBC-OS-HEM \$6.50
UBC-OS-OAK 10.96

7-1/4" x 3/4" x 3/4"
UBC-IS-HEM \$2.67
UBC-IS-OAK 3.90